

1. MECHANICAL DIMENSIONS :

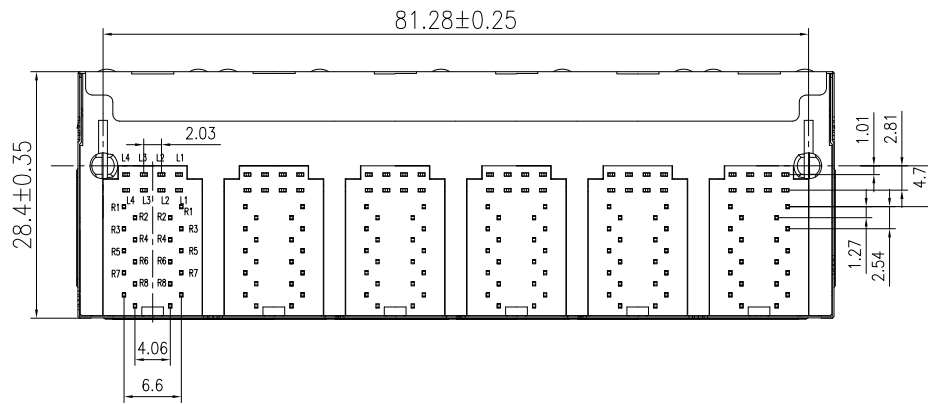
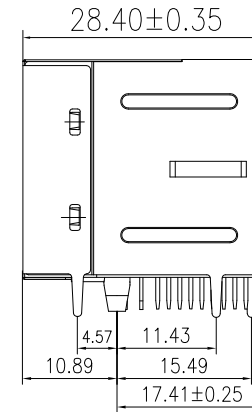
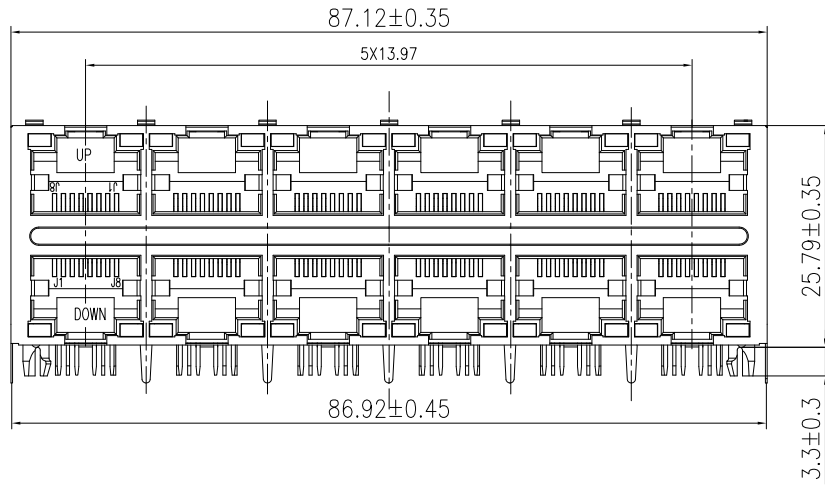

MATERIAL:

HOUSING: HIGH TEMP.THERMOPLASTIC(UL 94V-0),BLACK
 SPRING WIRE: 0.35mm THICKNESS PHOSPHOR BRONZE

ALLOY SELECTIVE GOLD PLATING OVER NICKEL

SHIELDING: COPPER ALLOY WITH TIN PLATED

GOLD PLATING: GOLD ON CONTACT AREA

JACK CAVITY CONFORMS TO FCC RULES AND REGULATIONS,PART 68 SUBPART F.

REV.	ECN. NO.	DRAWN	DATE
A	NEW	JOHN	26/03/2015

DST-conn Tech. Co., Ltd.



⊗:QUALITY CONTROL ITEM		GENERAL TOLERANCE		PART NO.: 26JBWPD-xxxxx		
APPROVED		.X± 0.38	X.'± 2'	TITLE:RJ45 2X6 PORT 8P8C		
CHECKED		.XX± 0.25	.X'± 1'	W/ LED , SHELL , T/S		
DRAWN		.XXX± 0.13		UNIT: mm	SCALE: 1:1	SHEET: 1/3
						REV.: A

說明: △ :備註 ◇ :版本變更 ① :尺寸序號 ■ :重點尺寸 ▼ :CPK尺寸

SIZE: A4

2. PCB LAYOUT :

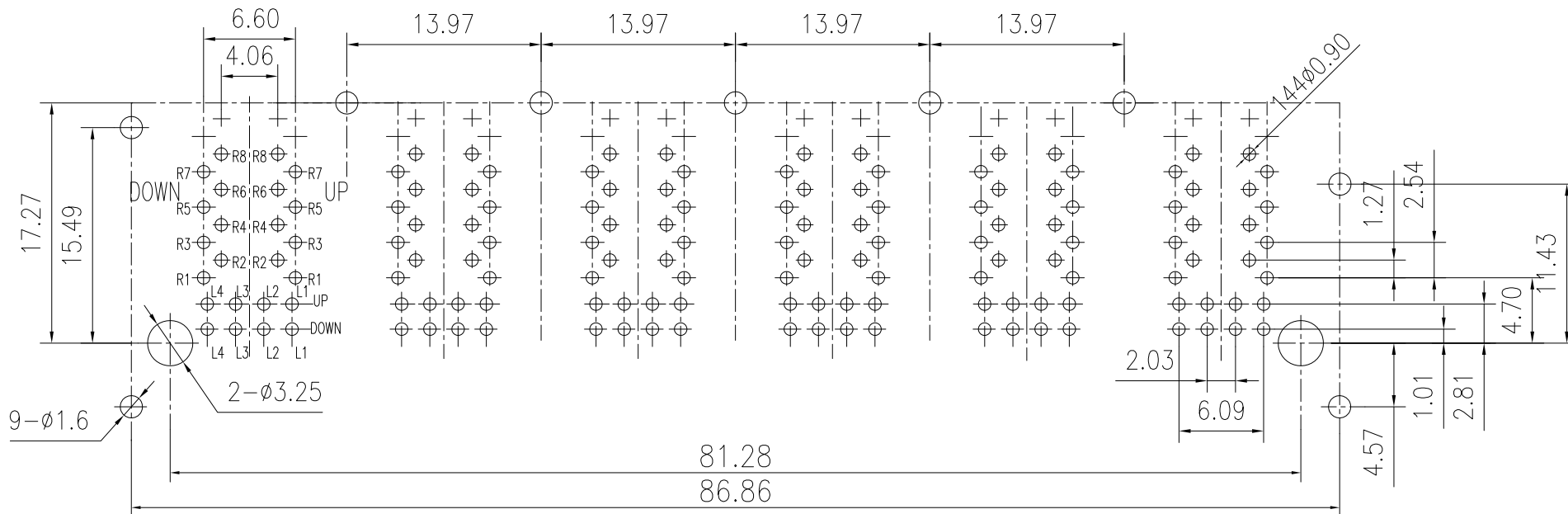

SUGGESTED PCB LAYOUT

(TOP VIEW)

DIMENSIONAL TOLERANCE: .XX ±0.05[0.002]

REV.	ECN. NO.	DRAWN	DATE
A	NEW	JOHN	26/03/2015

DST-conn Tech. Co., Ltd.



⊗:QUALITY CONTROL ITEM		GENERAL TOLERANCE	PART NO.: 26JBWPD-xxxxx		
APPROVED		.X± 0.38 X:± 2'	TITLE:RJ45 2X6 PORT 8P8C		
CHECKED		.XX± 0.25 .X'± 1'	W/ LED , SHELL , T/S		
DRAWN		.XXX± 0.13	UNIT: mm	SCALE: 1:1	SHEET: 2/3
					REV.: A

說明: △ :備註 ◇ :版本變更 ① :尺寸序號 ■ :重點尺寸 ▼ :CPK尺寸

SIZE: A4

3. SCHEMATIC :

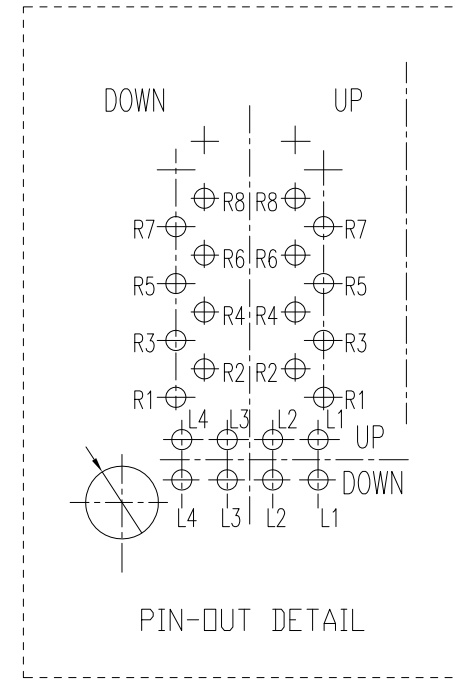
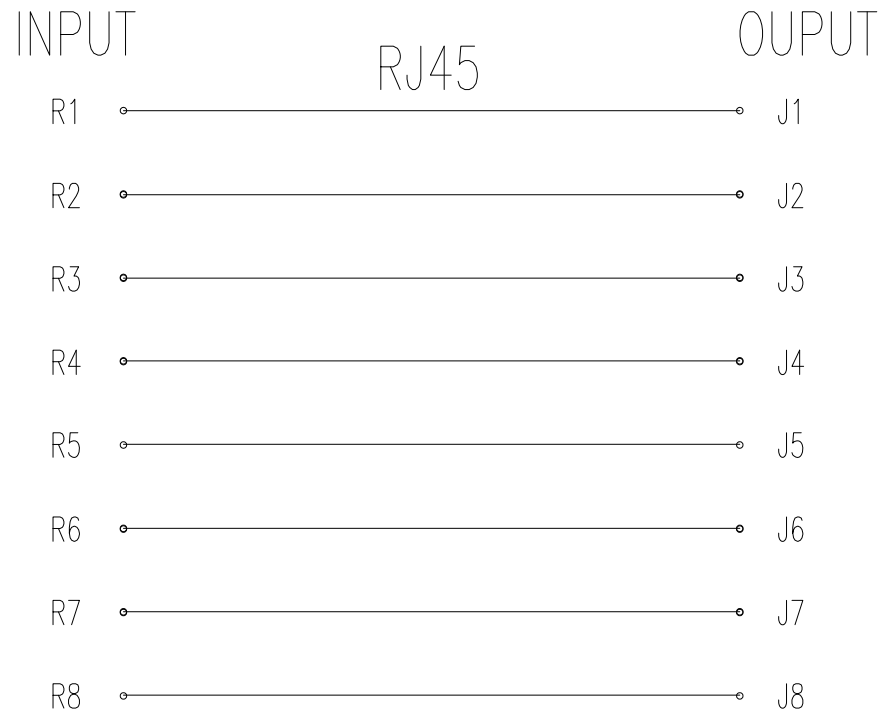

4. LED SCHEMATIC :

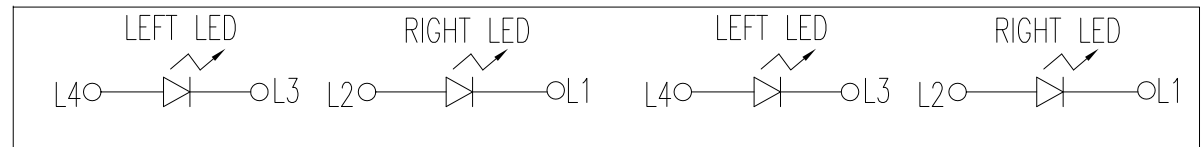

REV.	ECN. NO.	DRAWN	DATE
A	NEW	JOHN	26/03/2015

DST-conn Tech. Co., Ltd.



⊗:QUALITY CONTROL ITEM		GENERAL TOLERANCE		PART NO.: 26JBWPD-xxxxx		
APPROVED		.X± 0.38	X.'± 2'	TITLE:RJ45 2X6 PORT 8P8C		
CHECKED		.XX± 0.25	.X'± 1'	W/ LED , SHELL , T/S		
DRAWN		.XXX± 0.13		UNIT: mm	SCALE: 1:1	SHEET: 3/3
						REV.: A

說明: △ :備註 ◇ :版本變更 ① :尺寸序號 ■ :重點尺寸 ▼ :CPK尺寸

SIZE: A4